



SNOB SANITARY WARE

Design By : YO...R Graphics, 02822-224570



**SNOB SANITARY WARE LLP**  
Mfg. of SANITARY WARE  
Bhojapara Survey No. 57/2, Lunsar Road, Near Multi stone Vitrified,  
Ta. Wankaner, Dis. MORBI (GUJARAT) India  
Phone : +91 9978699521, 9978699522.  
E-mail : snobsanitaryware@gmail.com Web : www.snobsanitaryware.com

# 2021 COLLECTION

## SANITARY WARES





Perfection, Perception, and Performance, when the three combine, gives birth to something new, acceptable, and truly not believed before.

For years, Sanitaryware markets have been selling the same kind of products. With a theme of Freshness, in the mind and zeal to be ahead of the market, SNOB SANITARY, is presenting the fresh and colorful assortment of sanitaryware delights.

It has been very challenging. Our team had to go beyond their traditional thinking to roll out these exciting designs that have been never before been manufactured in India. This collection is the union of lots of beautiful design aspects coexisting into one.

In a nutshell, taking quality and customer satisfaction as the base of brand name, maintaining the lead of Ceramic Sanitary Industry of fashion and design, taking the concepts of the time on the basis of unique style to drive the business, SNOB SANITARY plays a vital role in supplying unmatched quality products along with best service through our esteemed dealers.



# INDEX

- 06 One Piece Closet
- 10 Wall Hung Closet
- 14 Water Closet
- 16 Table Top
- 23 Counter Basin
- 24 Counter Sink
- 25 Wash Basin Pedestal
- 31 Wash Basin Half Pedestal
- 33 One Piece Basin
- 35 One Piece Wall Hung Basin
- 36 Wash Basin
- 42 Pan
- 44 Urinal & Trap
- 47 Designer Series



## WATER SAVING

Our WCs have a special bowl structure and are specifically designed to flush with both lower (2.5/4 litre) and typical (3/6 litre) water volumes.

By using less water, these water saving WCs benefit you and the environment. All Home Decor standard height wall-hung frames come with dual flush function as standard in both 2.5/4 litre and 3/6 litre options.



## SPACE SAVING

A wall-hung WC takes up less room than a conventional WC, and the concealed installation offers flexibility in confined spaces. The range of compact WCs have shorter projection, saving even more space.



## ACCESSIBLE

These products are wheelchair accessible and provide enhanced convenience in the bathroom.

## RIM-LESS WC pan

### RIM-LESS TECHNOLOGY

Offering effortless cleaning and innovative, hygienic design. Home Decor's rimless WC pan eliminates the areas where germs gather and multiply, giving a superior level of hygiene.

### WASHBASIN FORMS

Washbasins can be used with a pedestal as well as being wall-hung. Basins suitable for use with a counter top can be fitted in three alternative ways:



### FISCHER

A simple, elegant installation system for use with wall-hung WCs. The fixings are hidden from sight by the use of internal ABS sleeves, creating a clean, smooth design.



{ Style For  
Beautiful Life }

▶ one piece closet



- ECO FRIENDLY
- EASY TO CLOSE
- GERM FREE
- DUAL FLUSH

**1001 - FLAT (Wash Down)**  
L 670, W 350, H 725mm  
S Trap - 225mm, 100mm. P Trap - 180mm

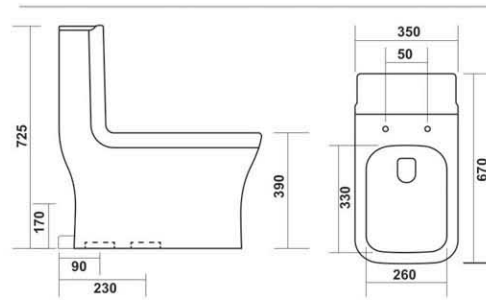

- ECO FRIENDLY
- EASY TO CLOSE
- GERM FREE
- DUAL FLUSH

**1002 - FERRO (Wash Down)**  
L 700, W 380, H 670mm  
S Trap - 225mm, P Trap - 180mm

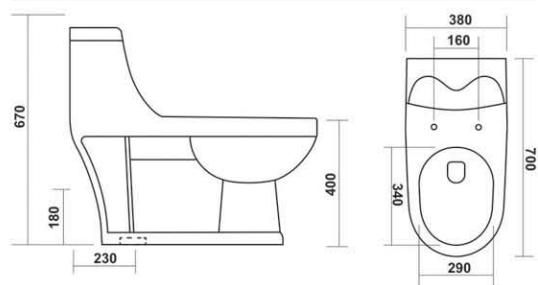

- ECO FRIENDLY
- EASY TO CLOSE
- GERM FREE
- DUAL FLUSH

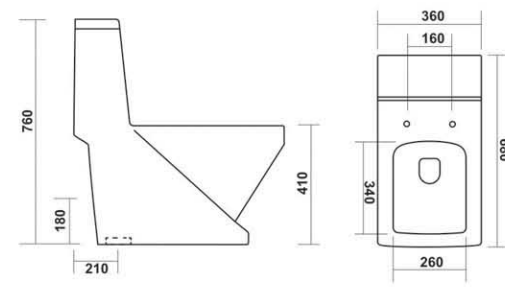

**1003 - FEBIA (Wash Down)**  
L 680, W 360, H 760mm  
S Trap - 225mm, P Trap - 180mm

▶ one piece closet



- ECO FRIENDLY
- EASY TO CLOSE
- GERM FREE
- DUAL FLUSH

**1004 - FENIX (Wash Down)**  
L 720, W 370, H 740mm  
S Trap - 225mm, P Trap - 180mm

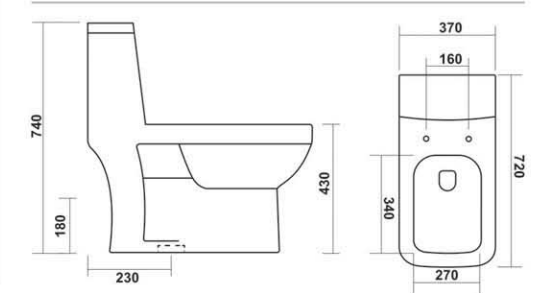

**1005 - FEA (Wash Down)**  
L 700, W 380, H 690mm  
S Trap - 225mm, P Trap - 180mm

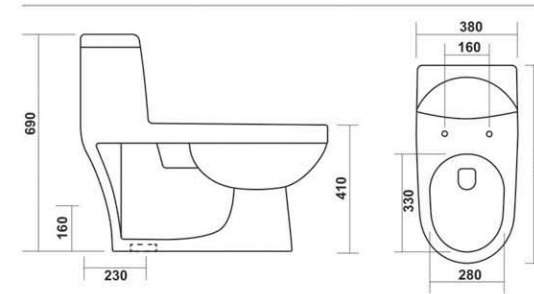

- ECO FRIENDLY
- EASY TO CLOSE
- GERM FREE
- DUAL FLUSH



▶ one piece closet



- ECO FRIENDLY
- EASY TO CLOSE
- GERM FREE
- DUAL FLUSH

**1006 - FALCON (Wash Down)**  
L 730, W 360, H 680mm  
S Trap - 225mm

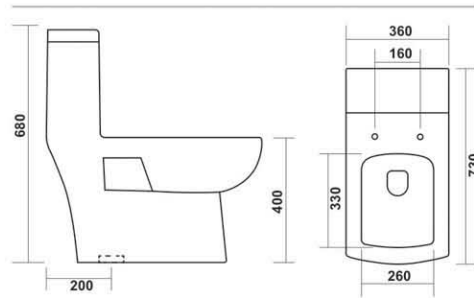

- ECO FRIENDLY
- EASY TO CLOSE
- GERM FREE
- DUAL FLUSH

**1007 - FUSION (Syphonic)**  
L 630, W 380, H 760mm  
S Trap - 225mm, 300mm

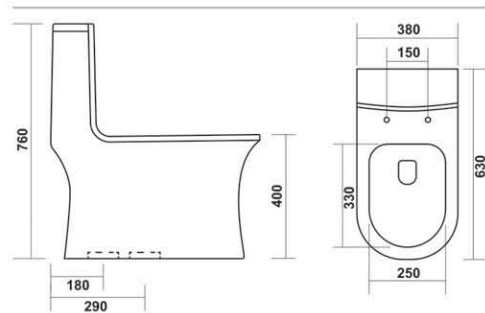

- ECO FRIENDLY
- EASY TO CLOSE
- GERM FREE
- DUAL FLUSH

**1008 - FLORA (Wash Down)**  
L 680, W 360, H 740mm  
S Trap - 100mm, 225mm. P Trap - 180mm

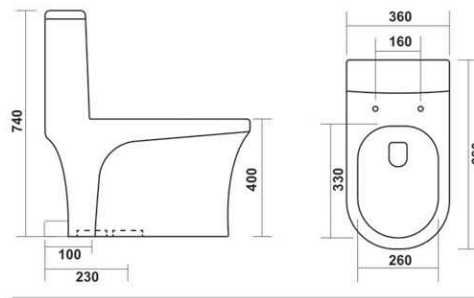

▶ one piece closet



- ECO FRIENDLY
- EASY TO CLOSE
- GERM FREE
- DUAL FLUSH

**1009 - FORD (Wash Down)**  
L 660, W 320, H 800mm  
S Trap - 225mm, 100mm. P Trap - 180mm

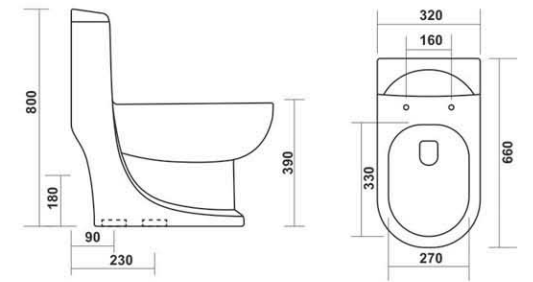

- ECO FRIENDLY
- EASY TO CLOSE
- GERM FREE
- DUAL FLUSH

**1010 - FRESCO (Syphonic)**  
L 660, W 360, H 740mm  
S Trap - 225mm

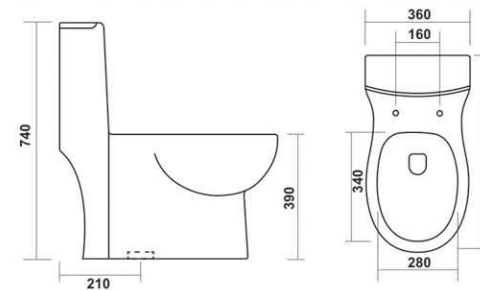

▶ wall hung closet



2001 - MILANO  
L 550, W 350, H 375mm

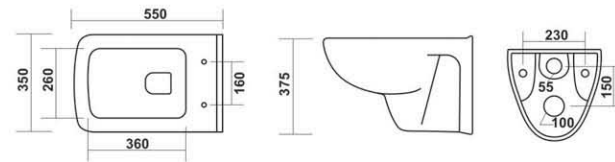

2002 - MEGA  
L 510, W 350, H 300mm

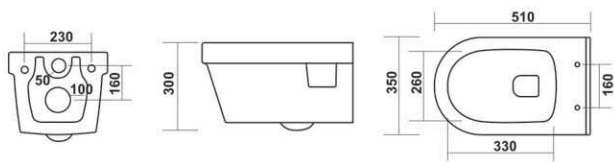

2003 - MAX  
L 490, W 370, H 320mm

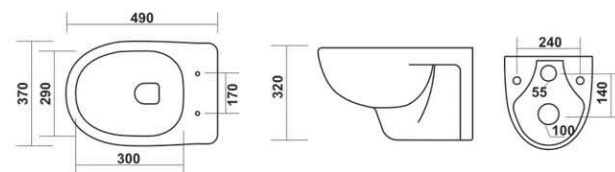

2004 - METRIX  
L 530, W 370, H 380mm

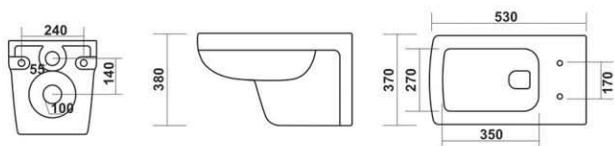

▶ wall hung closet



2005 - MARVEL  
L 540, W 360, H 370mm

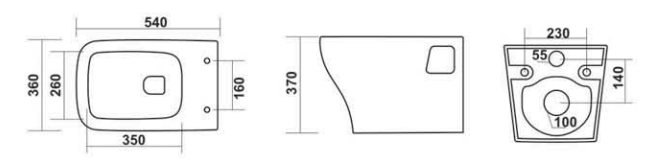

2006 - MODENA  
L 510, W 360, H 400mm

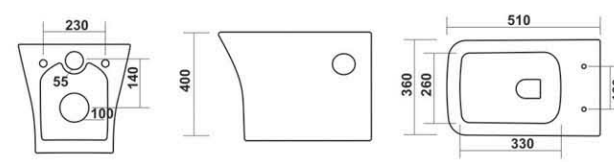
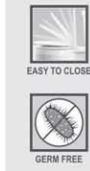

2007 - MARK  
L 550, W 370, H 400mm

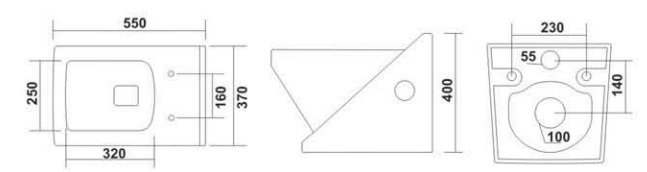
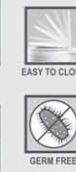

2008 - METRO  
L 510, W 350, H 360mm

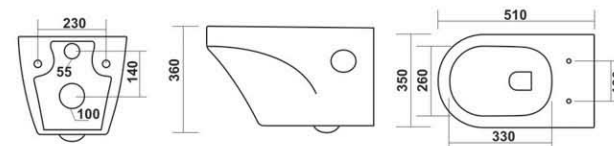

▶ wall hung closet



2009 - MINTO  
L 630, W 360, H 355mm

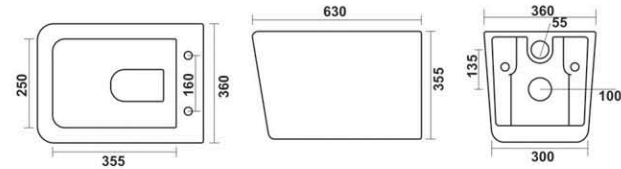
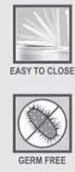

2010 - MOON  
L 490, W 360, H 360mm

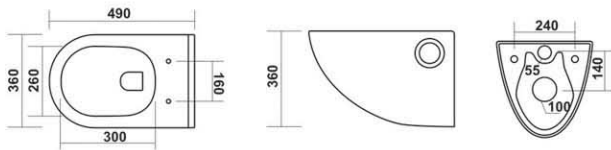

2011 - MARVITO (COUPLE SET)  
L 670, W 370, H 330mm TANK : L 370, W 190, H 320mm

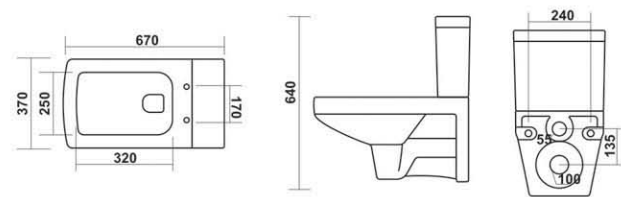
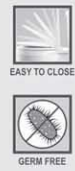

▶ wall hung closet



2012 - MARBO  
L 520, W 355, H 380mm

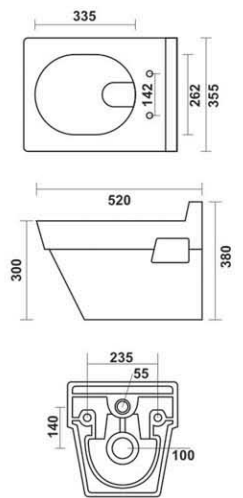

2013 - MASSIVE  
L 510, W 376, H 360mm

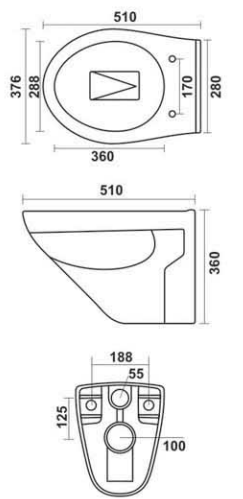



**6001 - EWC 'S'**  
L 530, W 370, H 415mm

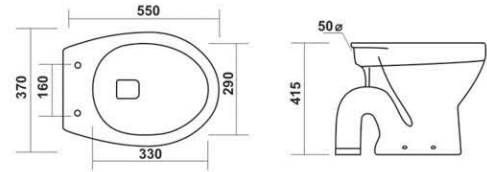

**6002 - EWC 'P'**  
L 550, W 370, H 415mm

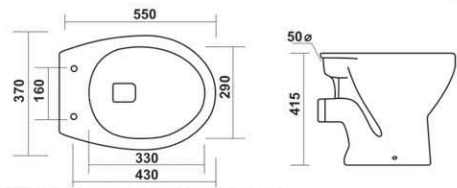

**6003 - CANDY**  
L 560, W 360, H 415mm

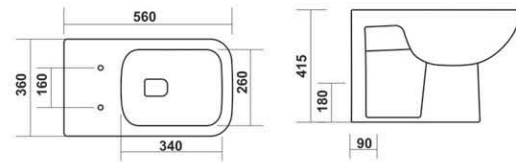

**6004 - EWC CONCEALED**  
L 560, W 380, H 420mm

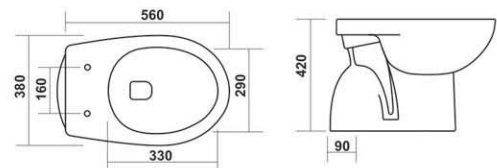

**6005 - ANGLO 'S'**  
L 570, W 460, H 410mm

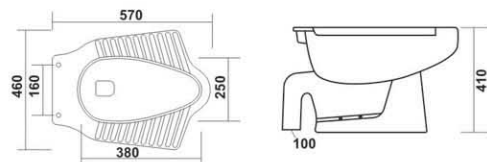

**6006 - ANGLO 'P'**  
L 570, W 460, H 410mm

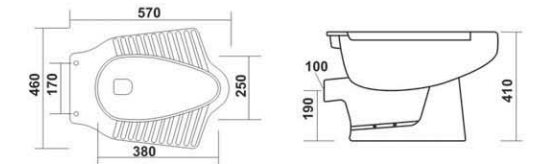

**6007 - CANVAS E.W.C.**  
L 520, W 345, H 390mm

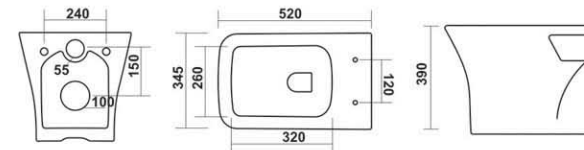
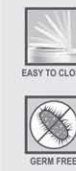

**ITALIAN E.W.C.**  
L 670, W 420, H 390mm TANK : L 420, W 190, H 370mm

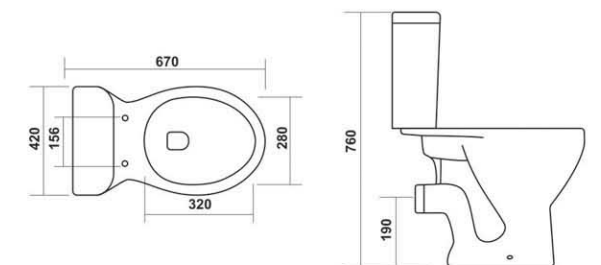



▶ table top basin



7001 - STYLE  
L 460, W 305, H 130mm

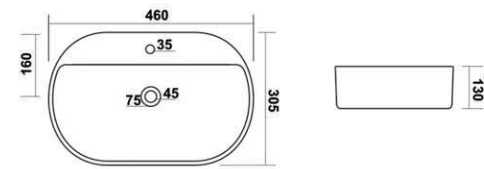

7002 - CAPSULE  
L 520, W 325, H 130mm

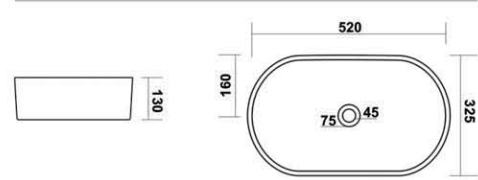

7003 - PLUTO  
L 515, W 325, H 180mm

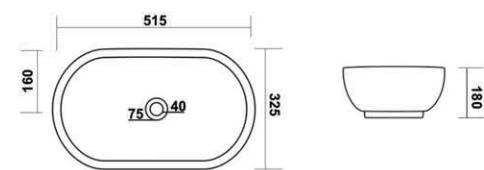

7004 - TITAN  
L 410, W 410, H 145mm

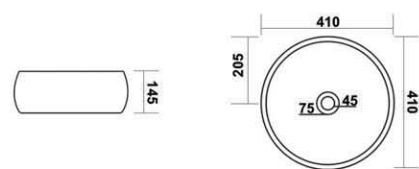

▶ table top basin



7005 - RECTA  
L 485, W 370, H 130mm

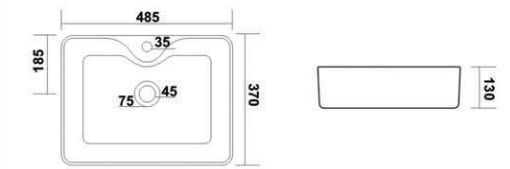

7006 - VENIS  
L 460, W 380, H 140mm

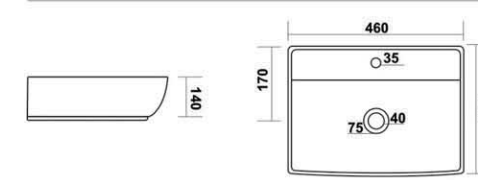

7007 - SYMON  
L 440, W 450, H 135mm

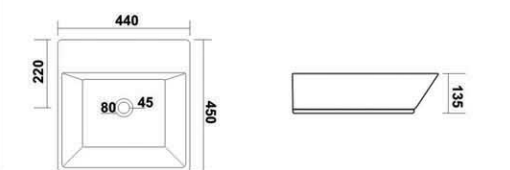

7009 - ORBIT  
L 600, W 420, H 150mm

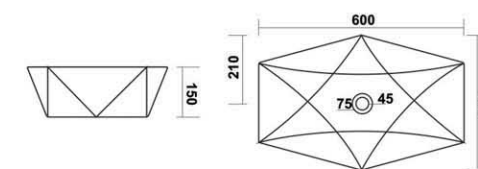

▶ table top basin



7008 - ARC  
L 585, W 435, H 180mm

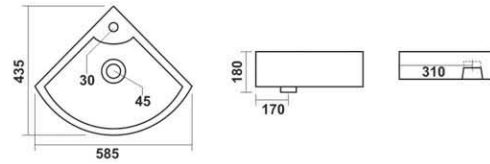

7010 - CELLO  
L 390, W 390, H 150mm

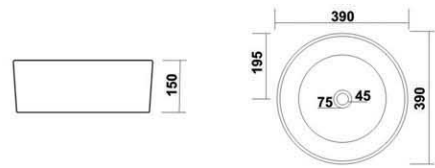

7011 - ZETA  
L 600, W 400, H 140mm

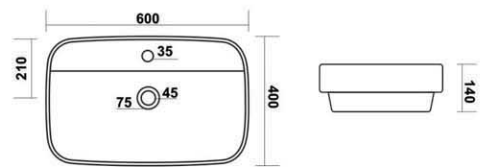

▶ table top basin



7012 - CYBER  
L 465, W 335, H 140mm

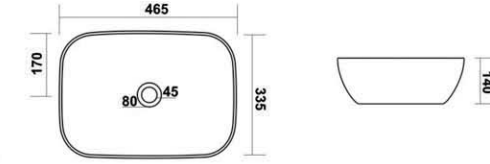

7013 - VENTO  
L 540, W 410, H 170mm

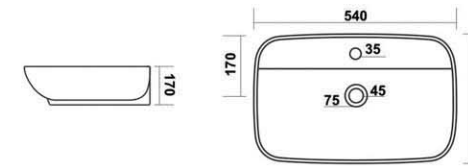

7014 - ICON  
L 420, W 420, H 210mm

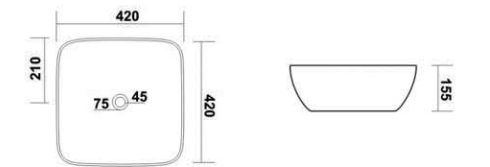

▶ table top basin



**7015 - LECTO**  
L 490, W 415, H 160mm

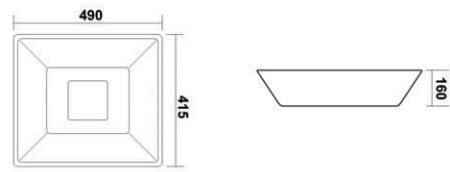

**7016 - SLEEK**  
L 460, W 330, H 155mm

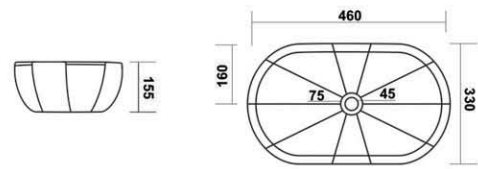

**7017 - SLICE**  
L 350, W 350, H 150mm

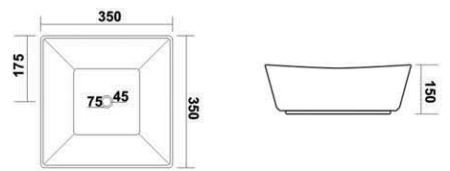

**7018 - DELTA**  
L 500, W 350, H 155mm

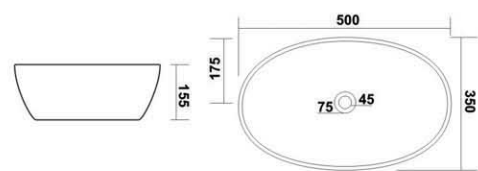

▶ table top basin



**7019 - CLASSIC**  
L 400, W 400, H 130mm

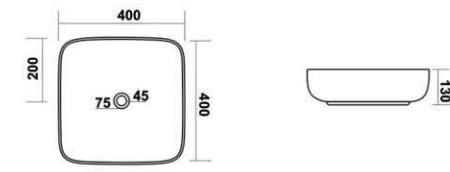

**7020 - SPENZO**  
L 410, W 350, H 155mm

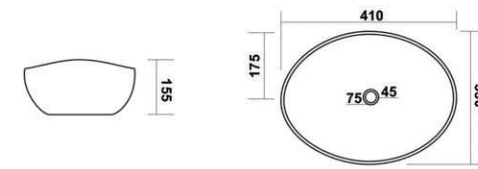

**7021 - APPLE**  
L 420, W 420, H 130mm

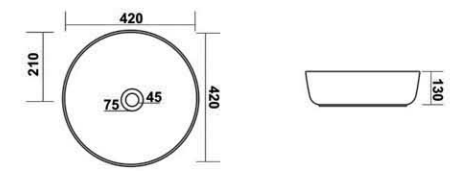

**7022 - RADO**  
L 440, W 440, H 150mm

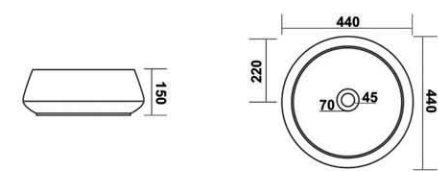

▶ table top basin



7023 - DELL  
L 410, W 410, H 140mm

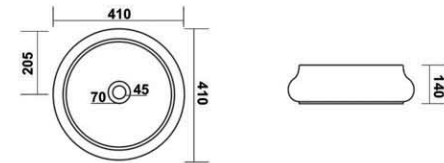

7024 - NELCO  
L 420, W 320, H 150mm

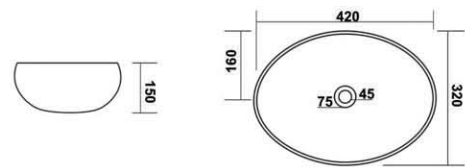

7025 - COSMO  
L 525, W 325, H 125mm

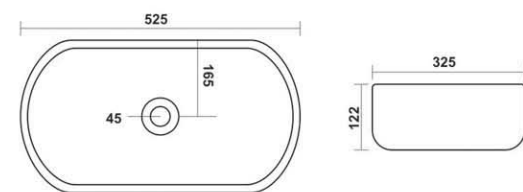

▶ counter basin



101 - AQUA TOP COUNTER  
L 630, W 480, H 300mm

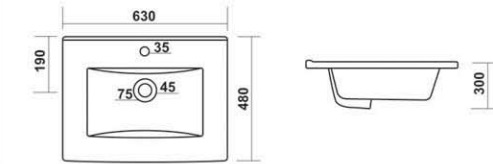

102 - OVEL TOP COUNTER  
L 580, W 420, H 205mm

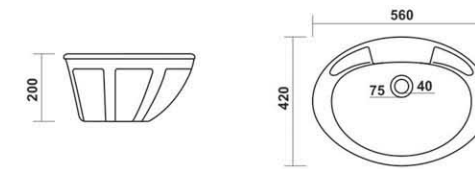

103 - UNDER COUNTER  
L 560, W 410, H 220mm

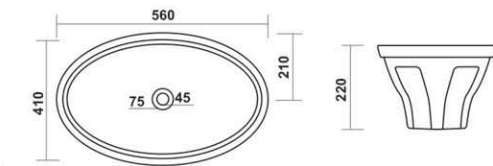

104 - UNDER COUNTER  
L 495, W 320, H 180mm

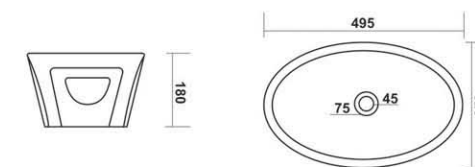



**201 - LAB SINK**  
L 505, W 365, H 210mm

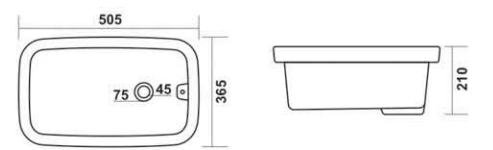

**202 - LAB SINK**  
L 620, W 480, H 260mm

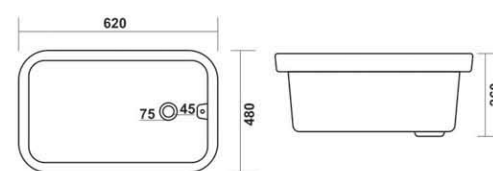

**SILVER SET - WB 8005 - PED 9004**  
L 625, W 500, H 900mm

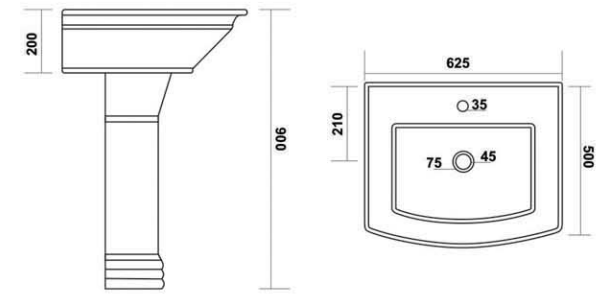

**CUBO SET - WB 3010 - PED 9002**  
L 480, W 400, H 840mm

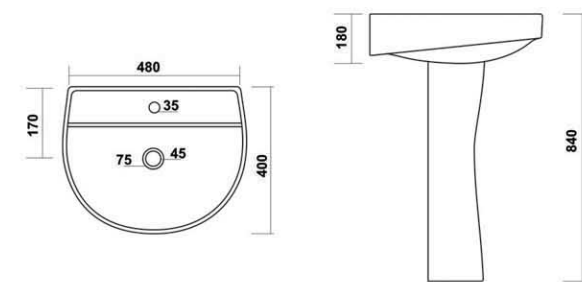

**DIAMOND SET - WB 8011 - PED 9008**  
L 590, W 500, H 890mm

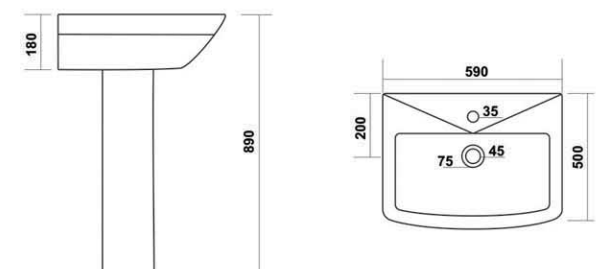

▶ wash basin pedestal



LOTUS SET - WB 8001 - PED 9001  
L 590, W 455, H 880mm

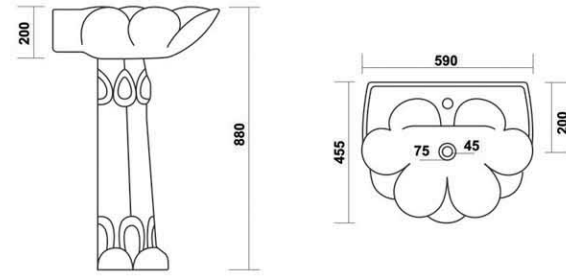

ELITE SET - WB 8002 - PED 9002  
L 530, W 430, H 885mm

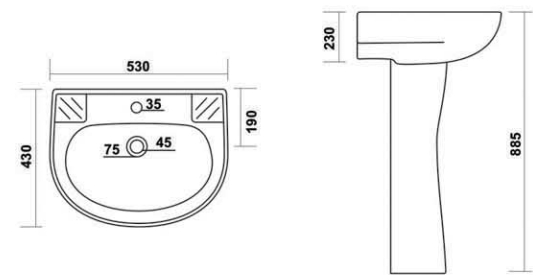

DELITE SET - WB 8003 - PED 9002  
L 570, W 420, H 860mm

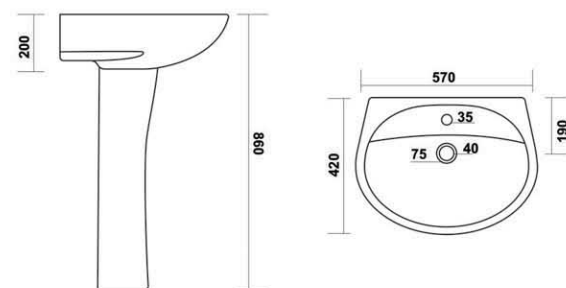

▶ wash basin pedestal



PRINCE GOLD SET - WB 8004 - PED 9003  
L 660, W 530, H 1050mm

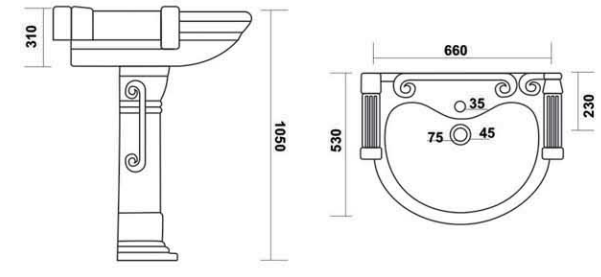

SERENA SET - WB 8006 - PED 9005  
L 600, W 490, H 950mm

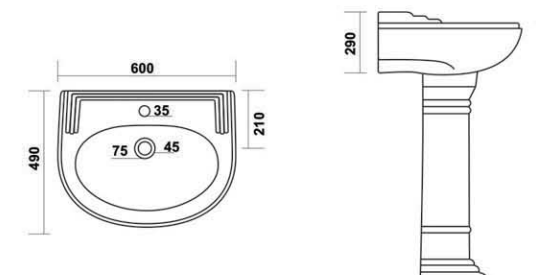

DOLPHIN SET - WB 8007 - PED 9006  
L 540, W 460, H 840mm

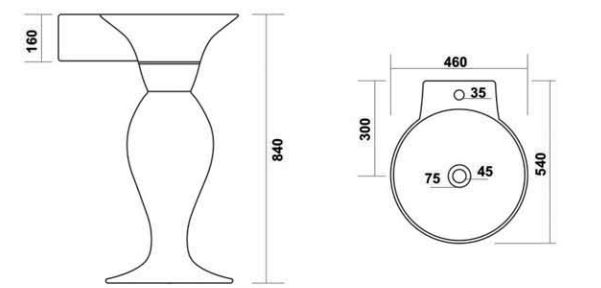

► wash basin pedestal



**SION SET - WB 8008 - PED 9007**  
L 600, W 470, H 880mm

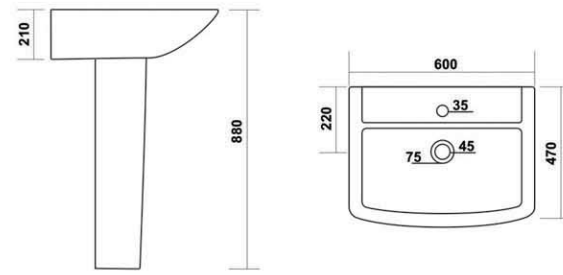

**SIMON SET - WB 8009 - PED 9007**  
L 600, W 480, H 885mm

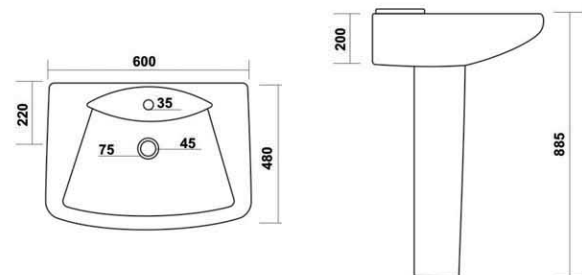

**SPYKAR SET - WB 8010 - PED 9007**  
L 520, W 445, H 860mm

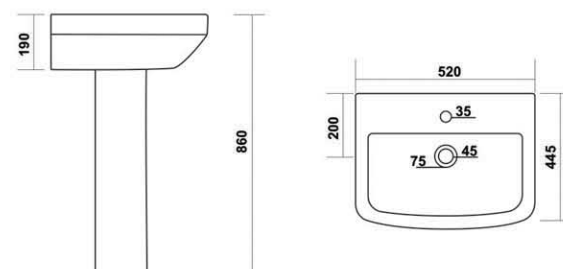

► wash basin pedestal



**ROYAL SET - WB 8012 - PED 9009**  
L 600, W 440, H 880mm

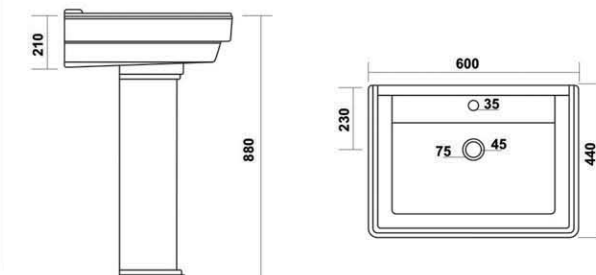

**PLAZMA SET - WB 3014 - PED 9014**  
L 470, W 340, H 830mm

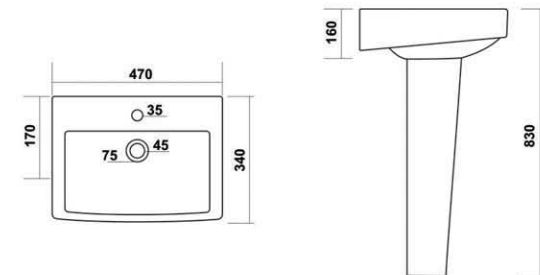

**DOVEL SET - WB 3015 - PED 9014**  
L 485, W 360, H 840mm

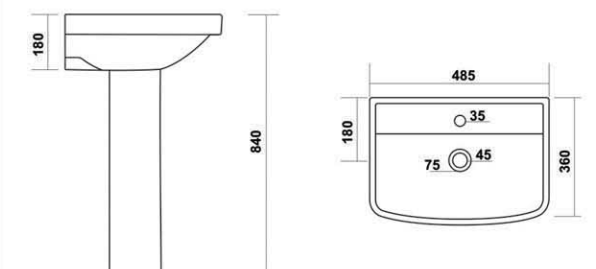

▶ wash basin pedestal



PENGVIN SET - WB 8013 - PED 9006  
L 575, W 453, H 875mm

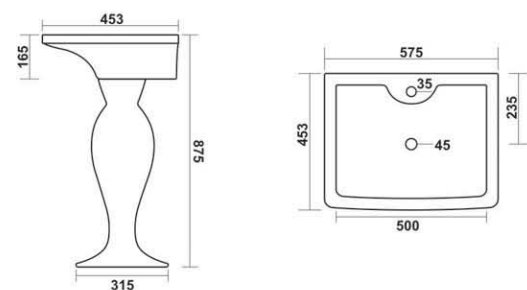

▶ wash basin half pedestal



DOLPHIN HALF SET  
WB 8007 - PED 9010  
L 540, W 460, H 500mm

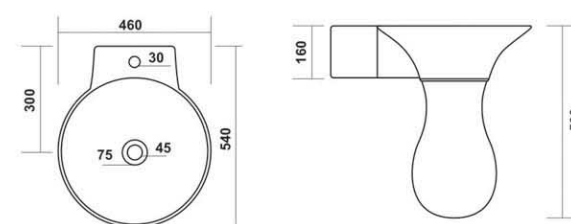

SONATA SET - WB 8014 - PED 9015  
L 525, W 447, H 842mm

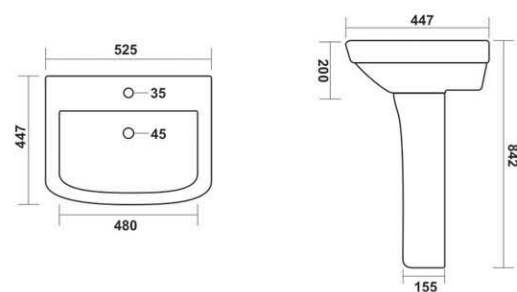

SPYKAR HALF SET  
WB 8010 - PED 9013  
L 520, W 440, H 520mm

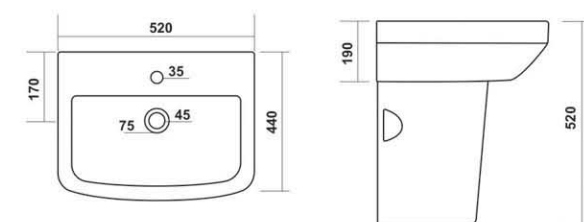



▶ wash basin half pedestal



CUBO HALF SET  
WB 3010 - PED 9012  
L 480, W 400, H 460mm

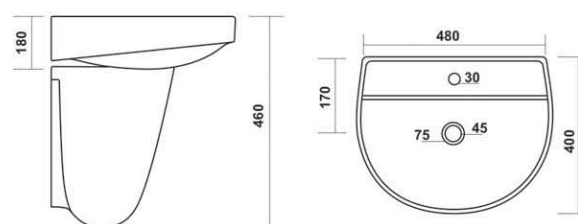

ELITE HALF SET  
WB 8002 - PED 9011  
L 530, W 430, H 460mm

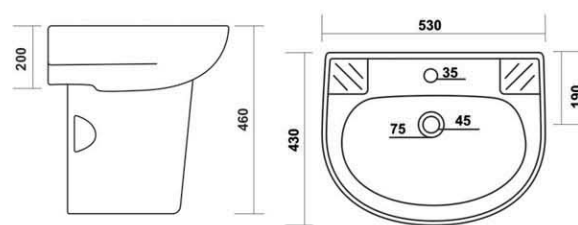

▶ one piece basin



VITTO - 4023  
L 413, W 413, H 830mm

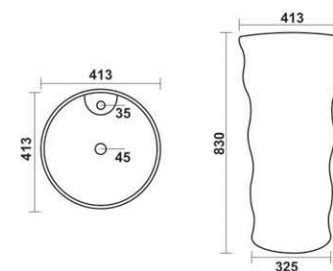

▶ one piece basin



ROCCA - 4021  
L 380, W 380, H 860mm

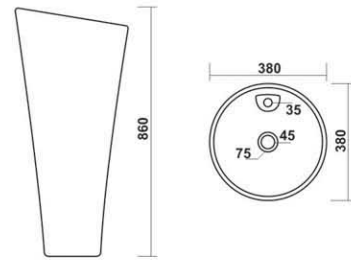

LATTO - 4022  
L 400, W 400, H 810mm

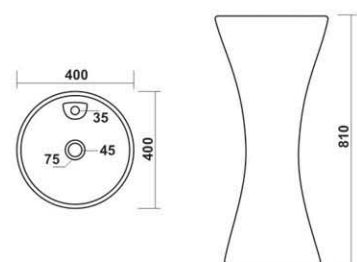

▶ one piece wall hung basin



4001 - POLO  
L 500, W 445, H 380mm

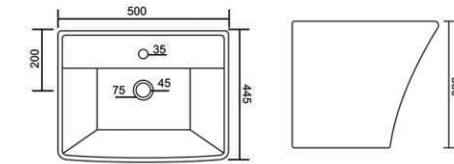

4002 - TORA  
L 460, W 355, H 315mm

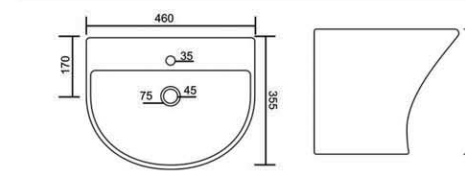

4003 - TOYO  
L 475, W 420, H 345mm

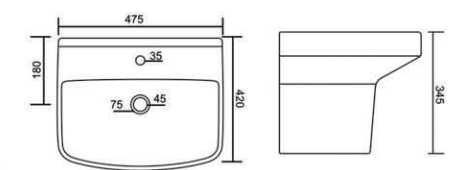

4004 - FOOTBALL  
L 460, W 355, H 315mm

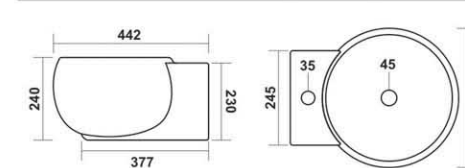



**3001 - SUNNY**  
L 470, W 380, H 200mm

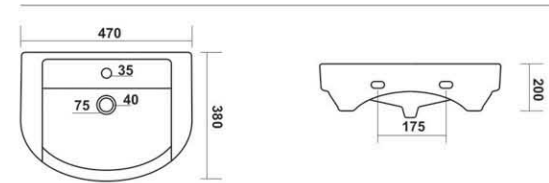

**3002 - OMEGA**  
L 470, W 310, H 200mm

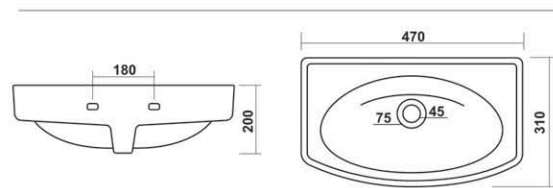

**3003 - HEXA**  
L 350, W 290, H 150mm

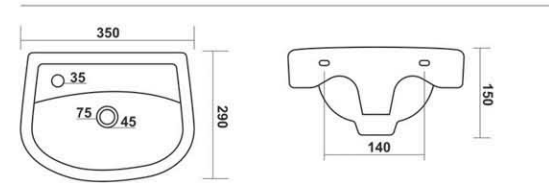

**3004 - CORUS**  
L 460, W 250, H 160mm

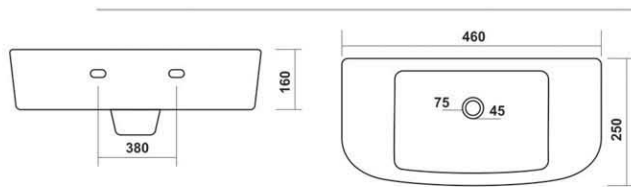

**3005 - NOVEL**  
L 340, W 340, H 140mm

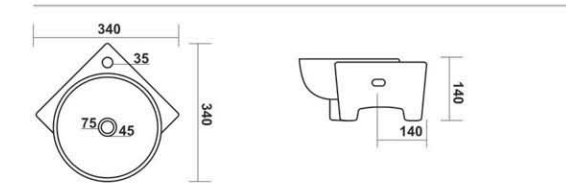

**3006 - YETI**  
L 425, W 250, H 130mm

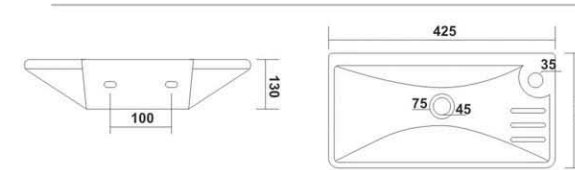

**3007 - CORNER**  
L 420, W 400, H 210mm

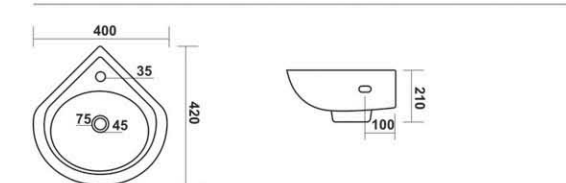

**3008 - REX**  
L 420, W 290, H 160mm

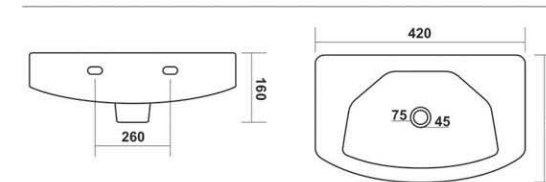

**3009 - LIZA**  
L 470, W 270, H 170mm

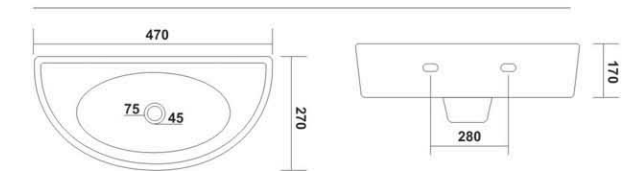



**3010 - CUBO**  
L 480, W 400, H 180mm

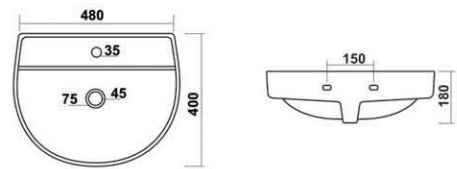

**3012 - SHARP**  
L 320, W 240, H 180mm

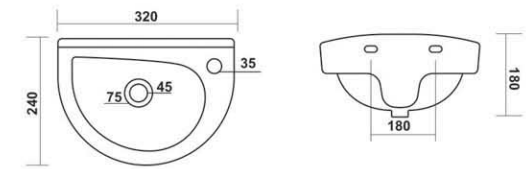

**3013 - SPARROW**  
L 650, W 410, H 190mm

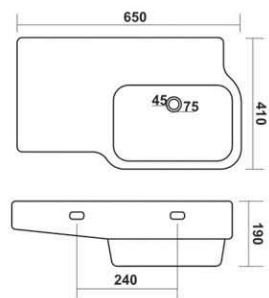

**3014 - PLAZMA**  
L 470, W 340, H 160mm

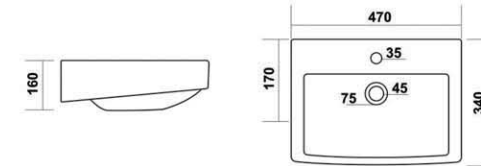

**3015 - DOVEL**  
L 485, W 360, H 180mm

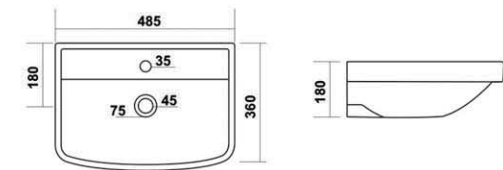

**3011 - NEON**  
L 410, W 330, H 140mm

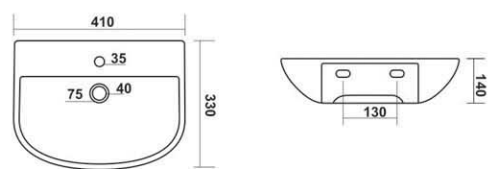

**3016 - RUBI**  
L 370, W 270, H 130mm

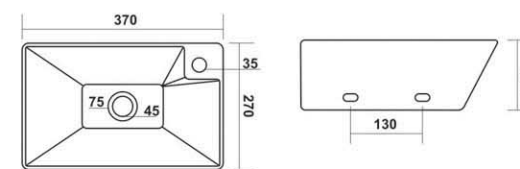



3017 - SWING  
L 360, W 335, H 140mm

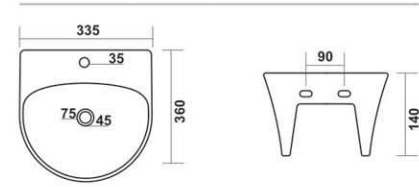

3018 - VIVA  
L 340, W 340, H 140mm

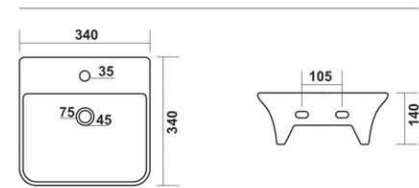

8002 - ELITE  
L 530, W 430, H 230mm

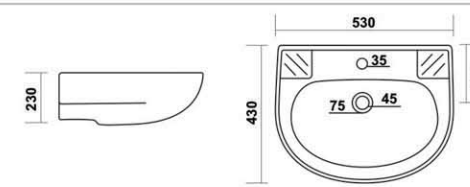

8003 - DELITE  
L 570, W 420, H 200mm

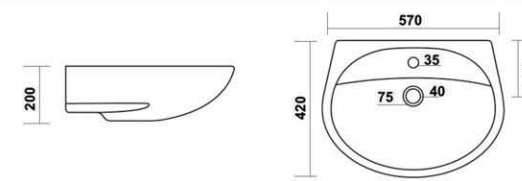



5001 - ORISSA PAN 20''  
L 520, W 410, H 270mm

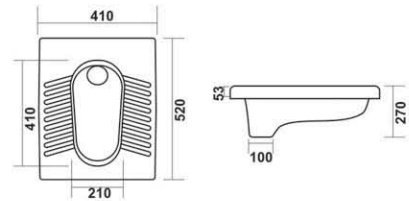

5002 - ORISSA PAN 21''  
L 560, W 430, H 280mm

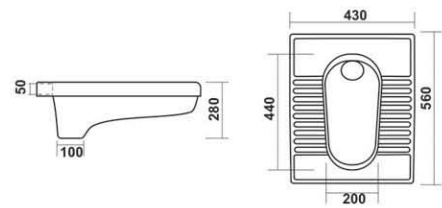

5003 - ORISSA PAN 23''  
L 610, W 430, H 290mm

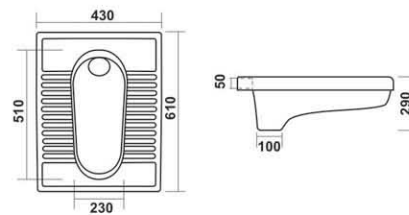

5004 - CITY PAN 20''  
L 520, W 420, H 190mm

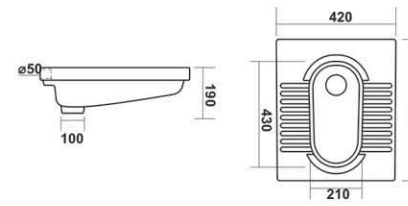

5005 - AQUA PAN 21''  
L 550, W 450, H 290mm

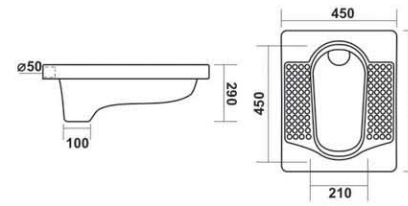

urinal



5009 - ULTRA  
L 370, W 330, H 610mm

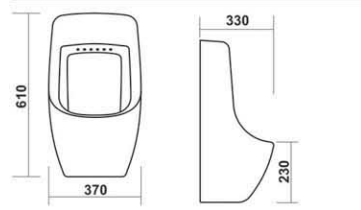

5010 - LARGE URINAL  
L 390, W 360, H 620mm

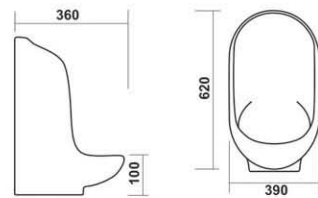

5011 - CARGO  
L 280, W 270, H 400mm

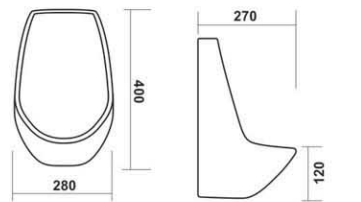

5012 - FLATBACK URINAL  
L 330, W 250, H 400mm

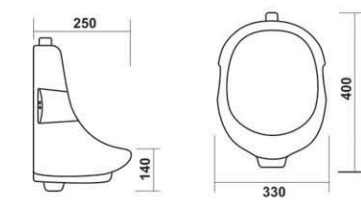

urinal & trap



5013 - SQUATTING  
L 470, W 370, H 100mm

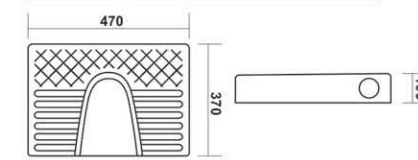

5014 - CORNER URINAL  
L 300, W 270, H 350mm

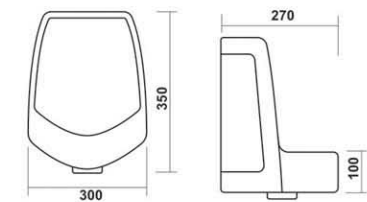

P - TRAP BIG



S - TRAP



DESIGNER SERIES



▶ wash basin pedestal



DOLPHIN SET  
ART - 002



DOLPHIN SET  
ART - 003



DOLPHIN SET  
ART - 004



DOLPHIN SET  
ART - 005



DOLPHIN SET  
ART - 006



▶ wash basin pedestal



DOLPHIN SET  
ART - 007



DOLPHIN SET  
ART - 008



DOLPHIN SET  
ART - 009



DOLPHIN SET  
ART - 010



DOLPHIN SET  
ART - 011

▶ wash basin pedestal



DOLPHIN SET  
ART - 012



DOLPHIN SET  
ART - 013



DOLPHIN SET  
BLACK



DOLPHIN SET  
ART - 014



DOLPHIN SET  
ART - 016

▶ wash basin pedestal



DOLPHIN SET  
ART - 017



DOLPHIN SET  
ART - 018



DOLPHIN SET  
ART - 019



DOLPHIN SET  
ART - 020

▶ wash basin pedestal



DELITE SET  
ART - 002



DELITE SET  
ART - 003



DELITE SET  
ART - 004



DELITE SET  
ART - 005



DELITE SET  
ART - 006



DELITE SET  
ART - 007



DELITE SET  
ART - 008



DELITE SET  
ART - 009



DELITE SET  
ART - 010



DELITE SET  
ART - 011



SILVER SET  
ART - 001



SILVER SET  
ART - 002



DELITE SET  
ART - 012



SILVER SET  
ART - 003



SILVER SET  
ART - 004



PENGVIN SET  
ART - 001

▶ one piece basin



ROCCA  
ART - 001



ROCCA  
ART - 002



ROCCA  
ART - 003

▶ one piece basin



ROCCA  
ART - 007



ROCCA  
ART - 009



ROCCA  
ART - 008



ROCCA  
ART - 004



ROCCA  
ART - 005



ROCCA  
ART - 006



ROCCA  
ART - 010



ROCCA  
ART - 011

▶ one piece basin



LATTO  
ART - 001



LATTO  
ART - 002



LATTO  
ART - 003



LATTO  
ART - 006



LATTO  
ART - 004

▶ one piece basin



LATTO  
ART - 007



VITO  
ART - 001

▶ table top basin



CYBER  
ART - 001



CYBER  
ART - 002



CYBER  
ART - 003



CYBER  
ART - 004



CYBER  
ART - 005



CYBER  
ART - 006



CYBER  
ART - 008



CYBER  
ART - 009

▶ table top basin



CYBER  
ART - 010



CYBER  
BLACK



CLASSIC  
BLACK



RECTA  
ART - 001



RECTA  
ART - 002



RECTA  
ART - 003



RECTA  
FULL  
BLACK

▶ table top basin



PLUTO  
ART - 001



PLUTO  
ART - 002



PLUTO  
ART - 003



PLUTO  
ART - 004



PLUTO  
ART - 005



PLUTO  
ART - 006



DELTA  
BLACK



DELTA  
ART - 001

▶ table top basin



CAPSULE  
ART - 002



CAPSULE  
ART - 003



CAPSULE  
ART - 004



CAPSULE  
ART - 005



CAPSULE  
ART - 006



ICON  
ART - 001



ICON  
BLACK



ICON  
FULL  
BLACK

▶ table top basin



CELO  
ART - 001



CELO  
ART - 002



CELO  
ART - 003



CELO  
ART - 004



CELO  
ART - 005



CELO  
ART - 006



TITAN  
ART - 001



TITAN  
ART - 002

▶ table top basin



TITAN  
ART - 003



TITAN  
ART - 004



TITAN  
ART - 005



TITAN  
ART - 006



TITAN  
ART - 007



TITAN  
ART - 008



TITAN  
ART - 009



TITAN  
ART - 010



▶ table top basin



SPENZO  
ART - 001



SPENZO  
ART - 002



SPENZO  
ART - 003



SPENZO  
ART - 004



SPENZO  
ART - 005



SPENZO  
ART - 006



SPENZO  
ART - 007



SPENZO  
ART - 008

▶ table top basin



SPENZO  
ART - 009



APPLE  
ART - 001



APPLE  
ART - 002



APPLE  
ART - 003



DELL  
ART - 001



DELL  
ART - 002



DELL  
ART - 003



SLICE  
BLACK

▶ table top basin



FOOTBALL ART - 001



FOOTBALL ART - 002



FOOTBALL ART - 003



FOOTBALL ART - 004



RADO ART - 001



RADO ART - 002

▶ pan & closet



O.P. 21" RUSTIC R. BROWN



O.P. 21" RUSTIC S. BLUE



O.P. 21" RUSTIC MAGENTA



O.P. 21" RUSTIC BLACK



ORISSA PAN 21" RED

AVAILABLE COLOR

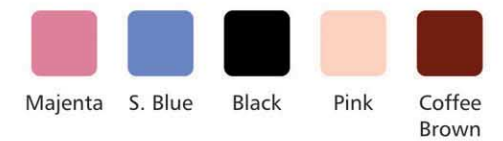

2005 - MARVEL BLACK



▶ concealed cistern & tank

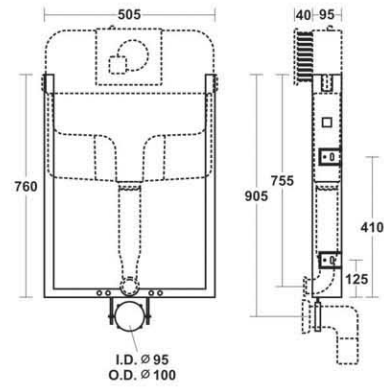

CONCEALED CISTERN

▶ seat cover & accessories



SLIM HYDRAULIC SEAT COVER SQUARE



SLIM HYDRAULIC SEAT COVER ROUND



HYDRAULIC SEAT COVER SQUARE



HYDRAULIC SEAT COVER ROUND



E.W.C. SEAT COVER ROUND



ANGLO SEAT COVER



CISTERN TOP PUSH



CISTERN FRONT PUSH



CISTERN DIAMOND (DUAL FLUSH)



CISTERN SIDE HANDLE



WALL HUNG CHAIR BRACKET



GASKET



INLET - OUTLET



SIDE CAP



WALL HUNG RACK BOLT



WASH BASIN RACK BOLT



ONE PIECE FITTING



URINAL BRACKET



JET SPRAY

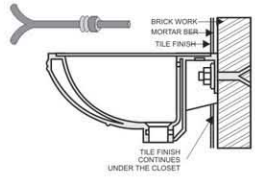

**WALL HUNG BASIN**

As per shown in the picture, the rag bolt must be grouted into the cement/concrete wall. The bolts must be fixed to the cement/concrete wall. Allow setting & checking than install it using nut and washer.

**COUNTER WASHBASIN**

At the beginning

1. A skilled or experienced person should install counter lavatories.
2. Avoid using adhesive with this product.
3. Check the waste area and supply tubing if required.
4. Do not open the lavatory from its protective carton until you are ready for installation.
5. Please follow all local building and plumbing codes.

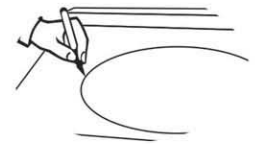

**MATERIAL & TOOLS**

Measure tape, Keyhole or saber saw, Hammer, Glasses, Rags or Paper toweling, Drill (1/2 dia, drill bit or larger), Pencil, sealant, sharp knife or scissors.

**INSTALLATION OF LAVATORY**

Please Note : Please install it in a way that future removal from underneath the counter top is possible without damaging the counter top.

1. Please check the desired location for clearance between the back splash, faucet, Fixture and cabinet.
2. Please cut the template.
3. Please carefully trace the template on the counter top directed.
4. Please mark the faucet hole centerline on the counter top.
5. Please drill a 1/2" pilot on the inside of the cut line.

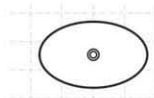

**For Wood Counter tops:**

1. Mark and per-drill the wood screw holes at the locations shown on the template.
2. Waterproof any exposed areas of wood.

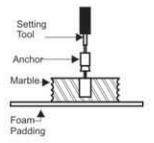

**For Marble Counter tops:**

1. Position the counter top upside down on foam padding to protect the surface. Mark and drill 3/6" holes 5/8" deep at the locations shown on the template.
2. Use a setting tool and hammer to secure the anchors.



**For All Installations:**

1. If the counter top has not been installed, install it at this time.
2. Drill the faucet holes according to the faucet installation instructions.
3. Install the faucet to the counter top according to the manufacture's instructions.
4. Install the drain to the lavatory according to the manufacture's instructions.

**MAINTENANCE**

Like any other part of your house, the bathroom can be made to look great and made to last long if it is taken care of regularly. To make your bathroom beautiful here are some invaluable tips.

**Wash Basin :**

A mild detergent can be used to wash the basin at least once a day. After washing, the basin should be wiped out clearly to avoid water stains.

**Closets :**

Cleanser like Harpic can be used to clear the closet with soft plastic brush, at least once a day.

To avoid minute discoloring, after flushing the toilet give it a once over with the soft brush.

Keep the toilet brush handy in a convenient stand nearby.

In case of toilets and basins, if there has been no maintenance since long period of time, water deposits and discoloration can form on the surface of areas that get wet. In such cases, these stains/marks can be removed with the help of a solution of dilute hydrochloric acid.

Clean with a soft cotton cloth and warm water with soap.

Do not use thinner, day cleaning liquids or powder paste. Use a liquid cleaner at least twice a week.

Use brasso or car rubbing compound and then polish with a cloth to remove fine scratches.

ITEM	PROBLEM	PROBABLE REASONS	CORRECTIVE ACTIONS
Wash Basins / Table Top	1. Overflow Chocked And Foul Bed Odor	Waste Coupling Used May Be Full Threaded	Waste Coupling Should Be Changed To Slot Cut Coupling
	2. Water Deposit On Tap Platform Area And Inside Bowl Area	Basin Is Not Fixed In Level Or Bracket Is Not In Level	Should Be Done By Proper Leveling
	3. There Is No Tap Hole In Basin	Tap Hole Could Be Semi Punched From Back Side	Tap Hole Should Be Created By Plumber From Semipunched Area
Ewc / Pan / Anglo Indian	1. Water Not Coming In Bowl Area While Flushing	Flush Bend Is Not Inserted Up To The End Of Inlet Hole	Insert The Flush Pipe Up To The End Of Inlet ( For Pan Closet: Check Whether Flush Pipe Is Not Covering Flush Hole Which Is In Both Side Of Inlet Wall
		Closet / Pan May Be Not Leveled	Should Be Done By Proper Leveling
One Piece Closet	1. Water Not Coming In Bowl Area While Flushing	Mechanism Inside Tank Could Not Working Properly	Change The Centre Pump Of Mechanism
		There Is No Water In Flush Tank	Increase The Ball Cock Height To The Max Level
	2. Water Is Continuously Leaking Inside The Bowl	Mechanism Inside Tank Could Not Working Properly	Change The Centre Pump Of Mechanism
	3. Water Quantity Insufficient For Effective Flushing	Ball Cock Height Adjusted At Lower Level	Increase The Ball Cock Height To The Max Level
Wallhung Water Closet	1. Water Not Coming In Bowl Area While Flushing	Flush Valve May Not Working Properly / Concealed Cistern Is Not Working Properly	Should Change Flush Valve / Concealed Cistern
		Flush Pipe Is Not Inserted Up To The End Of Inlet Hole	Insert The Flush Pipe Up To The End Of Inlet
	2. Water Is Continuously Leaking Inside The Bowl	Closet Is Not Leveled Properly	Closet Should Be In Proper Level
Couple Closet (2 Pcs Closet)	1. Uneven Flow Of Water From Both Side Of Closet Bowl	Both Arm Of Diverter Pipe Not Inserted Equally In Both Side Of The Closet	Both Arm Of Diverter Pipe Should Be Inserted Equally In Both Side Of The Closet
		Diverter Pipe Not Fixed Properly In The Outlet Of Cistern	Diverter Pipe Should Be Fixed Properly In The Outlet Of Cistern
	2. Water Is Leaking Between The Cistern And Closet	Rubber Ring Containing Bolt Is Not Tightened Properly	Rubber Ring Containing Bolt Should Be Tightened Properly

